

Dedicated  
timers

# Motion Detector - Retriggerable Single Shot HRD9 Power-Time Time Delay Relay



5

- 30 A SPDT N.O. Isolated Output Contacts
- 12 ... 230 V Operation in 5 Ranges
- Delays from 100 ms ... 100 m in 5 ranges
- 0.5% Repeat Timing Accuracy
- Fixed, External or Onboard Adjustment
- Encapsulated Circuitry

Approvals:

### Accessories

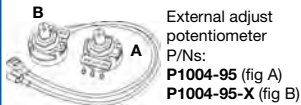

External adjust potentiometer  
P/Ns:  
P1004-95 (fig A)  
P1004-95-X (fig B)



Mounting bracket  
P/N: P1023-6



Female quick connect P/Ns:  
P1015-64 (AWG 14/16)  
P1015-13 (AWG 10/12)

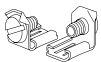

Quick connect to screw adaptor  
P/N: P1015-18



Versa-knob  
P/N: P0700-7

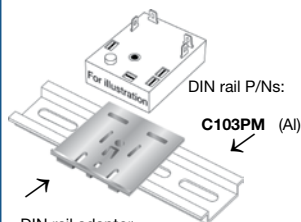

DIN rail P/Ns:

C103PM (A)

DIN rail adaptor  
P/N: P1023-20

See accessory pages for specifications.

### Description

The HRD9 Series combines an electromechanical relay output with microcontroller timing circuitry. It offers 12 to 230 V operation in five ranges and factory fixed, external, or onboard adjustable time delays with a repeat accuracy of +/-0.5%. The isolated output contact rating allows for direct operation of heavy loads such as compressors, pumps, blower motors, heaters, etc. The HRD9 is ideal for OEM applications where cost is a factor.

### Operation

Input voltage must be applied prior to and during timing. The output is de-energized. Upon closure of the initiate switch (momentary or maintained) the output energizes and the time delay starts. On completion of the delay period, the output de-energizes.

**Reset:** Reclosing the initiate switch during or after timing will reset the time delay and restart timing. Reset is also accomplished by removing and reapplying input voltage.

**Note:** Powering up the unit with the initiate switch closed will not energize the output relay or start timing.

### Connection

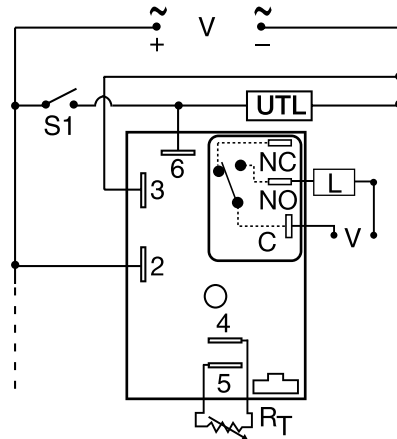

### Function

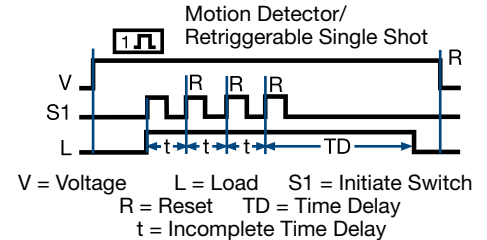

S1 = Initiate Switch L = Timed Load  
UTL = Untimed Load NO = Normally Open  
C = Common, Transfer Contact

NOTE: A knob, or terminals 4 & 5 are only included on adjustable units.  $R_T$  is used when external adjustment is ordered. Relay contacts are isolated. Dashed lines are internal connections. The untimed load is optional.

### Available Models-

HRD9112S

Don't see what you need? Call us for a minimum quantity and price quote!

### Ordering Table

HRD9 Series	X Input	X Adjustment	X Time Tolerance	X Time Delay *
	-1 - 12 V DC	-1 - Fixed	A - +/-1%	-0 - 0.1 ... 10 s
	-2 - 24 V AC	-2 - Onboard Knob	Blank - +/-5%	-1 - 1 ... 100 s
	-3 - 24 V DC	-3 - External Adjust		-2 - 10 ... 1000 s
	-4 - 120 V AC			-3 - 0.1 ... 10 m
	-6 - 230 V AC			-4 - 1 ... 100 m

Example P/N: HRD9421 Fixed - HRD941A0.5S

\* If Fixed Delay is selected, insert delay [0.1 ... 1000] followed by (S) sec. or [0.1 ... 100] (M) min.

# Motion Detector - Retriggerable Single Shot HRD9 Power-Time Time Delay Relay

Dedicated  
timers

## Technical Data

<b>Time Delay</b>		Microcontroller circuitry	
Type		100 ms ... 100 m in 5 adjustable ranges or fixed	
Range		+/-0.5 % or 20 ms, whichever is greater	
Repeat Accuracy		+/-1%, +/-5%	
Tolerance (Factory Calibration)		≤ 150 ms	
Reset Time		+/-2%	
Time Delay vs. Temperature & Voltage		≤ 20 ms (≤ 1500 operations per min.)	
Initiate Time			
<b>Input</b>			
Voltage		12 or 24 V DC; 24, 120, or 230 V AC	
Tolerance	12 V DC & 24 V DC	-15% ... +20%	
	24 ... 230 V AC	-20% ... +10%	
Line Frequency		50 ... 60 Hz	
Power Consumption		AC ≤ 4 VA; DC ≤ 2 W	
<b>Output</b>		Electromechanical relay	
Type		SPDT, isolated	
Form			
Ratings:		<b>SPDT-N.O.</b>	<b>SPDT-N.C.</b>
General Purpose	125/240 V AC	30 A	15 A
Resistive	125/240 V AC	30 A	15 A
	28 V DC	20 A	10 A
Motor Load	125 V AC	1 hp*	1/4 hp**
	240 V AC	2 hp**	1 hp**
Life		Mechanical -- 1 x 10 <sup>6</sup> ; Electrical -- 1 x 10 <sup>6</sup> , *3 x 10 <sup>4</sup> , **6,000	
<b>Protection</b>		IEEE C62.41-1991 Level A	
Surge		Encapsulated	
Circuitry		≥ 2000 V RMS terminals to mounting surface	
Dielectric Breakdown		≥ 100 MΩ	
Insulation Resistance		DC units are reverse polarity protected	
Polarity			
<b>Mechanical</b>		Surface mount with one #10 (M5 x 0.8) screw	
Mounting		3 x 2 x 1.5 in. (76.7 x 51.3 x 38.1mm)	
Package		0.25 in. (6.35 mm) male quick connect terminals	
Termination			
<b>Environmental</b>		-40°C ... +60°C/-40°C ... +85°C	
Operating/Storage Temperature		95% relative, non-condensing	
Humidity		≅ 3.9 oz (111 g)	
Weight			

5

## External Resistance vs Time Delay

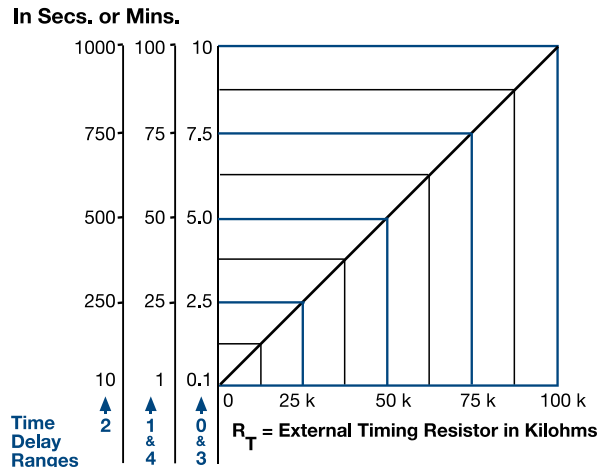

## Mechanical View

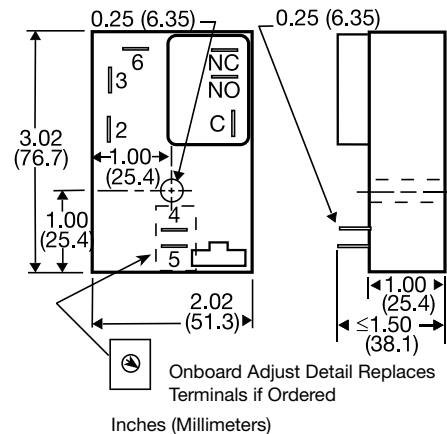

This chart applies to externally adjustable part numbers.

The time delay is adjustable over the time delay range selected by varying the resistance across the R<sub>T</sub> terminals; as the resistance increases the time delay increases.

When selecting an external R<sub>T</sub>, add the tolerances of the timer and the R<sub>T</sub> for the full time range adjustment.

**Examples:** 1 to 50 S adjustable time delay, select time delay range 1 and a 50 K ohm R<sub>T</sub>. For 1 to 100 S use a 100 K ohm R<sub>T</sub>.